

O8H203

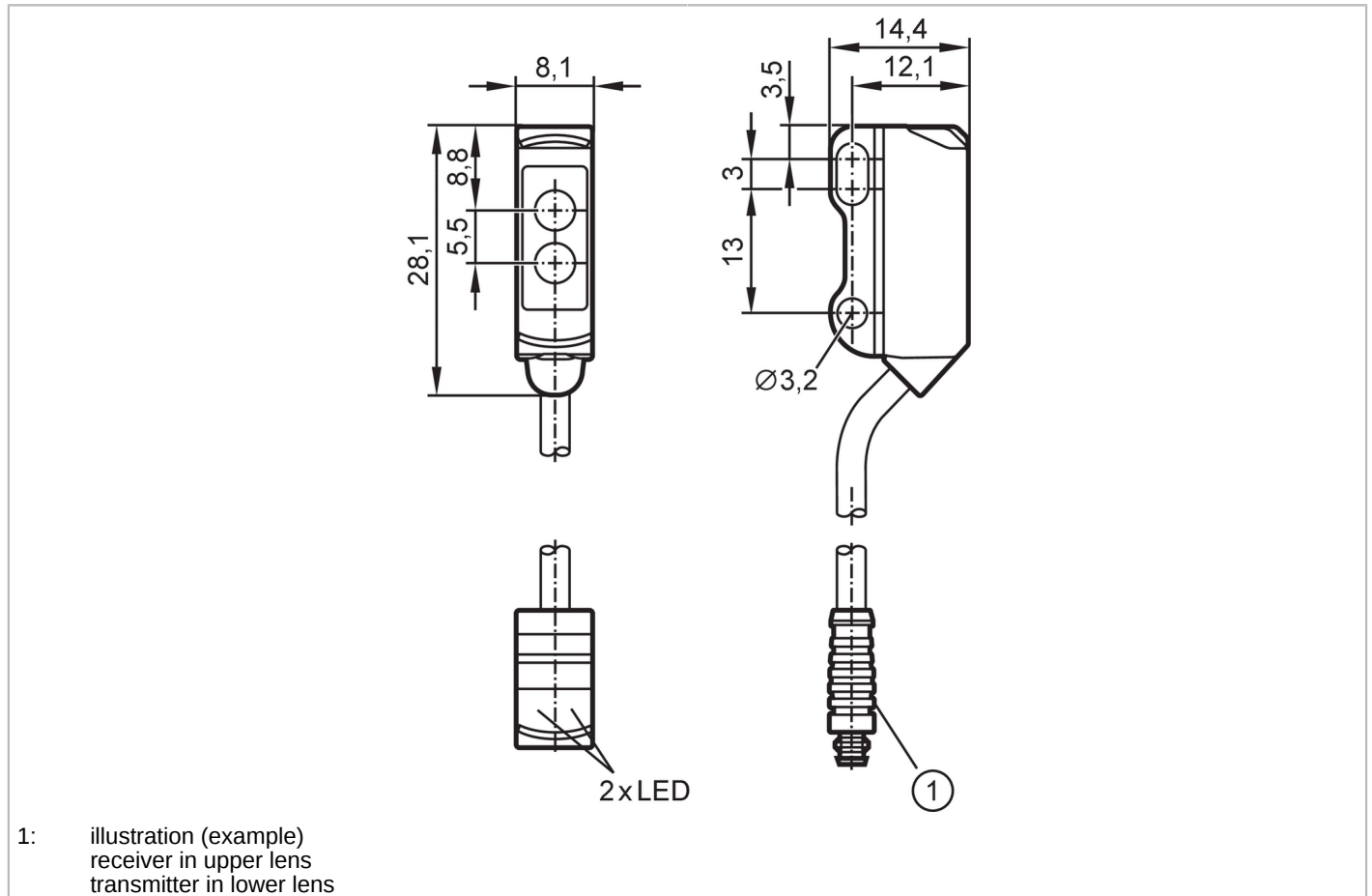

Diffuse reflection sensor with background suppression

O8H-HNKG/0,30M/AS/3P



Product characteristics	
Type of light	red light
Housing	rectangular
Application	
Special feature	Background suppression
Function principle	Diffuse reflection sensor
Application	Industrial applications / factory automation
Electrical data	
Operating voltage [V]	10...30 DC
Current consumption [mA]	20; ((24 V))
Protection class	III
Reverse polarity protection	yes
Type of light	red light
Wave length [nm]	633
Outputs	
Electrical design	NPN
Output function	light-on mode
Max. voltage drop switching output DC [V]	2.5

O8H203



Diffuse reflection sensor with background suppression

O8H-HNKG/0,30M/AS/3P

Permanent current rating of switching output DC [mA]	100
Switching frequency DC [Hz]	1000
Short-circuit protection	yes
Type of short-circuit protection	pulsed

Detection zone

Range [mm]	3...15; (white paper 200 x 200 mm)
Range on white object (90 % remission) [mm]	3...15
Range on grey object (18 % remission) [mm]	5...15
Range on black object (6 % remission) [mm]	5...15
Range adjustable	no
Max. light spot diameter [mm]	4
Light spot dimensions refer to	at maximum range
Background suppression available	yes

Operating conditions

Ambient temperature [°C]	-25...60
Protection	IP 65; IP 67

Tests / approvals

EMC	EN 60947-5-2	
MTTF [years]	757	
UL approval	Ta	-25...60 °C
	Enclosure type	Type 1
	voltage supply	Limited Voltage/Current
	UL approval no.	E015
	File number UL	E174191

Mechanical data

Weight [g]	22.7
Housing	rectangular
Dimensions [mm]	28.1 x 8.1 x 14.4
Materials	housing: ABS; rear of the housing: stainless steel (316L/1.4404)
Lens material	front pane:PMMA
Lens alignment	side lens

Displays / operating elements

Display	switching status	1 x LED, yellow
	operation	1 x LED, green

Remarks

Pack quantity	1 pcs.
---------------	--------

O8H203



Diffuse reflection sensor with background suppression

O8H-HNKG/0,30M/AS/3P

Electrical connection

Cable: 0.3 m, PVC; 3 x 0.08 mm²

Connector: 1 x M8; coding: A; Contacts: 3



Connection

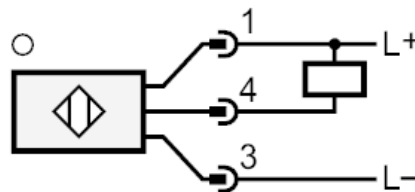

Diagrams and graphs

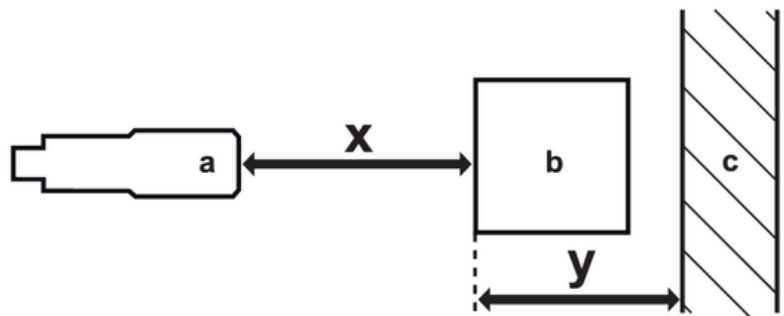

- a: sensor
- b: object
- c: background
- x: distance sensor/object [mm]
- y: min. distance object/background [mm]



Diffuse reflection sensor with background suppression

O8H-HNKG/0,30M/AS/3P

accuracy graph

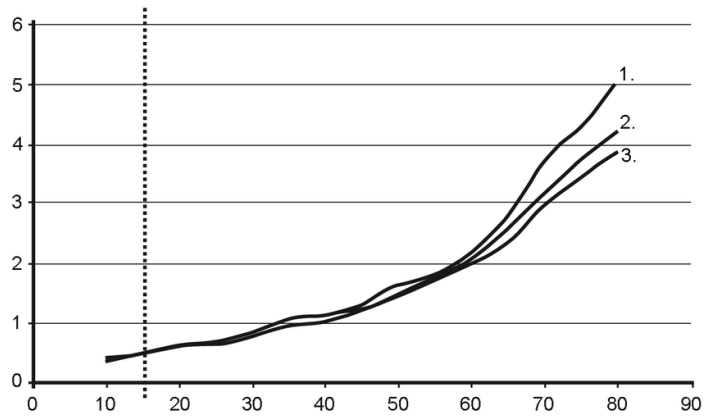

x: distance sensor/object [mm]

y: min. distance object/background [mm]

1 = object black (6 % remission) , background white (90 % remission)

2 = object grey (18 % remission) , background white (90 % remission)

3 = object white (90 % remission) , background white (90 % remission)