

O8H220

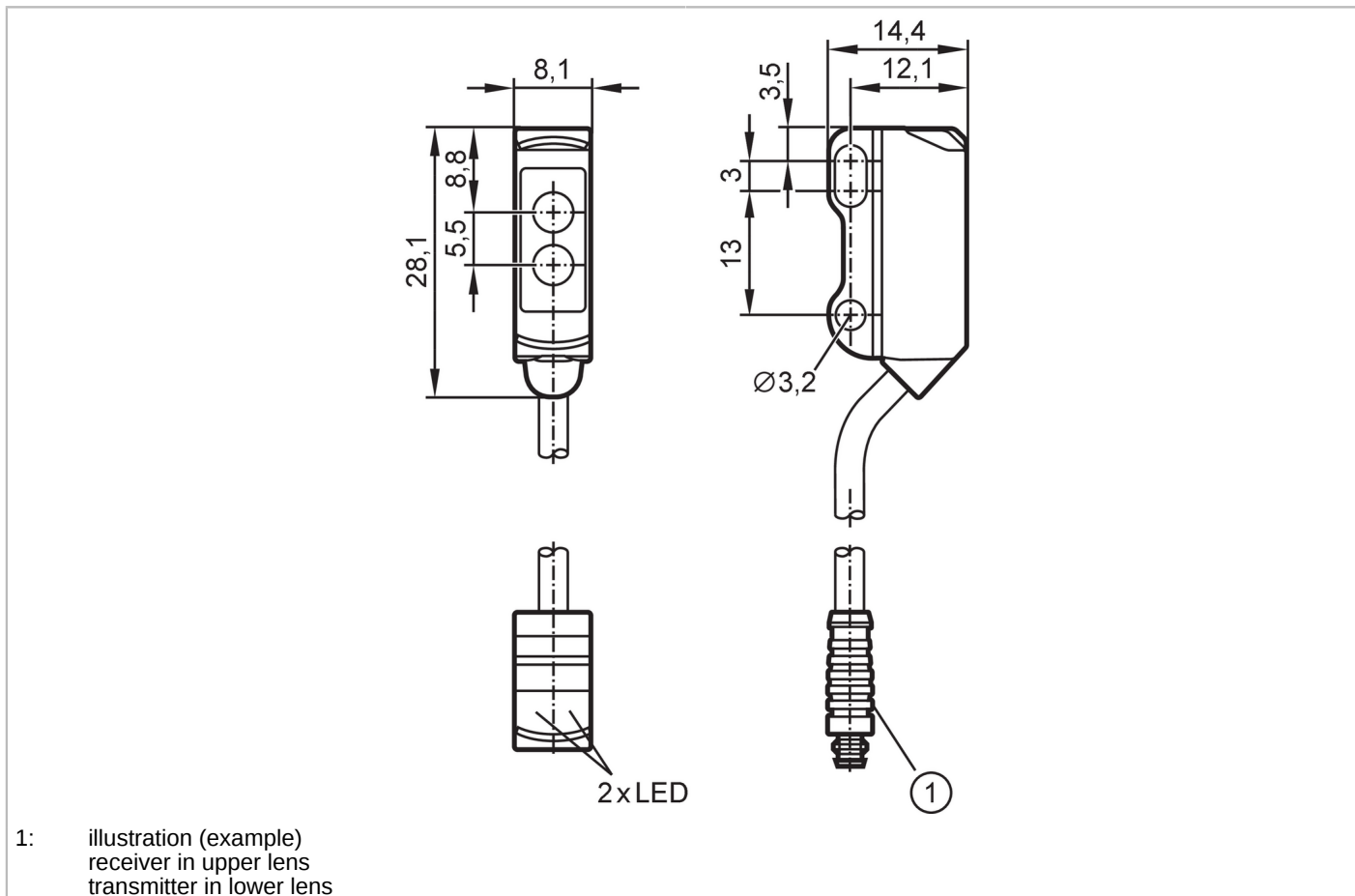

Diffuse reflection sensor with background suppression

O8H-FPKG/IO-Link/0,30M/AS/3P



Product characteristics	
Type of light	red light
Housing	rectangular
Application	
Special feature	Background suppression
Function principle	Diffuse reflection sensor
Application	Industrial applications / factory automation
Electrical data	
Operating voltage [V]	10...30 DC
Current consumption [mA]	20; ((24 V))
Protection class	III
Reverse polarity protection	yes
Type of light	red light
Wave length [nm]	633
Outputs	
Electrical design	PNP
Output function	light-on/dark-on mode; (programmable)
Max. voltage drop switching output DC [V]	2.5



Diffuse reflection sensor with background suppression

O8H-FPKG/IO-Link/0,30M/AS/3P

Permanent current rating of switching output DC [mA]	100
Switching frequency DC [Hz]	1000
Short-circuit protection	yes
Type of short-circuit protection	pulsed

Detection zone	
Range [mm]	1...80; (white paper 200 x 200 mm)
Range on white object (90 % remission) [mm]	1...80
Range on grey object (18 % remission) [mm]	3...76
Range on black object (6 % remission) [mm]	5...74
Setting range [mm]	10...80
Range adjustable	yes
Max. light spot diameter [mm]	4
Light spot dimensions refer to	at maximum range
Background suppression available	yes

Interfaces		
Communication interface	IO-Link	
Transmission type	COM2 (38,4 kBaud)	
IO-Link revision	1.1	
SDCI standard	IEC 61131-9	
Profiles	Smart Sensor - SSP 0	Generic Profiled Sensor
	Function	Device identification
	Function	Multiple switching signal
	Function	Device diagnosis
	Function	Teach channel
SIO mode	yes	
Required master port type	A	
Min. process cycle time [ms]	3	
IO-Link process data (cyclical)	function	bit length
	process value	8
	device status	4
	binary switching information	1
IO-Link functions (acyclical)	application specific tag; operating hours counter; switching cycles counter	
Supported DeviceIDs	Type of operation	DeviceID
	default	535

Operating conditions	
Ambient temperature [°C]	-25...60
Protection	IP 65; IP 67

Tests / approvals	
EMC	EN 60947-5-2
MTTF [years]	757

O8H220



Diffuse reflection sensor with background suppression

O8H-FPKG/IO-Link/0,30M/AS/3P

UL approval	Ta	-25...60 °C
	Enclosure type	Type 1
	voltage supply	Limited Voltage/Current
	UL approval no.	E017
	File number UL	E174191

Mechanical data

Weight	[g]	21.1
Housing		rectangular
Dimensions	[mm]	28.1 x 8.1 x 14.4
Materials		housing: ABS; rear of the housing: stainless steel (316L/1.4404)
Lens material		front pane:PMMA
Lens alignment		side lens

Displays / operating elements

Display	switching status	1 x LED, yellow
	operation	1 x LED, green

Remarks

Pack quantity	1 pcs.
---------------	--------

Electrical connection

Cable: 0.3 m, PVC; 3 x 0.08 mm²

Connector: 1 x M8; coding: A; Contacts: 3



Connection

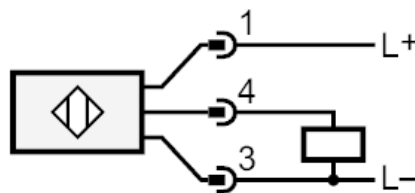



Diffuse reflection sensor with background suppression

O8H-FPKG/IO-Link/0,30M/AS/3P

Diagrams and graphs



- a: sensor
- b: object
- c: background
- x: distance sensor/object [mm]
- y: min. distance object/background [mm]

accuracy graph

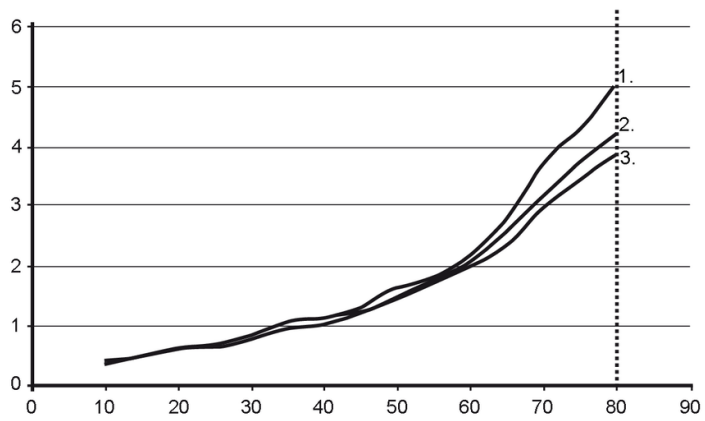

- x: distance sensor/object [mm]
- y: min. distance object/background [mm]
- 1 = object black (6 % remission) , background white (90 % remission)
- 2 = object grey (18 % remission) , background white (90 % remission)
- 3 = object white (90 % remission) , background white (90 % remission)