

SICK.COM



DATA SHEET

# GL6L-P3211

G6  
Photoelectric sensors

**SICK** Sensor Intelligence

## PHOTOELECTRIC SENSORS

## GL6L-P3211

## ORDERING INFORMATION

Type	part no.
GL6L-P3211	1117677

Further device versions and accessories at [www.sick.com/G6](http://www.sick.com/G6)



Illustration may differ

## DETAILED TECHNICAL DATA

## FEATURES

Functional principle	Photoelectric retro-reflective sensor	
Sensing range	Sensing range min.	0.08 m
	Sensing range max.	12 m
Maximum distance range from reflector to sensor (operating reserve 1)		0.08 m ... 12 m
Recommended distance range from reflector to sensor (operating reserve 2)		0.08 m ... 10 m
Reference reflector		Reflector P250F
Recommended sensing range for the best performance		0.08 m ... 4.2 m
Polarisation filter	Yes	
Emitted beam	Light source	Laser
	Type of light	Visible red light
	Shape of light spot	Point-shaped
	Light spot size (distance)	Ø 3.5 mm (1,000 mm)
Maximum dispersion of the emitted beam around the standardized transmission axis (squint angle)		< +/- 1.5° (at T <sub>0</sub> = +23 °C)
Key laser figures	Normative reference	IEC 60825-1 / CDRH 21 CFR 1040.10 & 1040.11
	Laser class	1 <sup>1)</sup>
	Wave length	680 nm
	Pulse duration	2 µs
	Maximum pulse power	≤ 11.9 mW
	Average service life	100,000 h at T <sub>a</sub> = +25 °C
Smallest detectable object (MDO) typ.	3.5 mm, at 1 m distance (object with 90% remission factor (corresponds to standard white according to DIN 5033))	
Adjustment	Potentiometer	For setting the sensing range

<sup>1)</sup> Do not intentionally look into the laser beam. Never point the laser beam at people's eyes.

	Operating mode switch	For inverting the switching function (light/dark switching)
Display	LED green	Operating indicator Static on: power on
	LED yellow	Status of received light beam Static on: object not present Static off: object present

<sup>1)</sup> Do not intentionally look into the laser beam. Never point the laser beam at people's eyes.

## SAFETY-RELATED PARAMETERS

MTTF <sub>D</sub>	1,005 years
DC <sub>avg</sub>	0 %
T <sub>M</sub> (mission time)	10 years

## ELECTRONICS

Supply voltage U <sub>B</sub>	10 V DC ... 30 V DC <sup>1)</sup>																
Ripple	< 5 V <sub>pp</sub>																
Usage category	DC-13 (According to EN 60947-5-2)																
Current consumption	≤ 20 mA, without load. At U <sub>B</sub> = 24 V																
Protection class	III																
Digital output	<table border="0"> <tr> <td>Number</td> <td>1</td> </tr> <tr> <td>Type</td> <td>PNP</td> </tr> <tr> <td>Switching mode</td> <td>Light/dark switching</td> </tr> <tr> <td>Signal voltage PNP HIGH/LOW</td> <td>Approx. U<sub>B</sub> - 3 V / 0 V</td> </tr> <tr> <td>Output current I<sub>max.</sub></td> <td>≤ 100 mA <sup>2)</sup></td> </tr> <tr> <td>Circuit protection outputs</td> <td>Reverse polarity protected Overcurrent protected Short-circuit protected</td> </tr> <tr> <td>Response time</td> <td>≤ 625 μs</td> </tr> <tr> <td>Switching frequency</td> <td>1,000 Hz <sup>3)</sup></td> </tr> </table>	Number	1	Type	PNP	Switching mode	Light/dark switching	Signal voltage PNP HIGH/LOW	Approx. U <sub>B</sub> - 3 V / 0 V	Output current I <sub>max.</sub>	≤ 100 mA <sup>2)</sup>	Circuit protection outputs	Reverse polarity protected Overcurrent protected Short-circuit protected	Response time	≤ 625 μs	Switching frequency	1,000 Hz <sup>3)</sup>
Number	1																
Type	PNP																
Switching mode	Light/dark switching																
Signal voltage PNP HIGH/LOW	Approx. U <sub>B</sub> - 3 V / 0 V																
Output current I <sub>max.</sub>	≤ 100 mA <sup>2)</sup>																
Circuit protection outputs	Reverse polarity protected Overcurrent protected Short-circuit protected																
Response time	≤ 625 μs																
Switching frequency	1,000 Hz <sup>3)</sup>																
Pin/Wire assignment	<table border="0"> <tr> <td>Function of pin 4/black (BK)</td> <td>Digital output, light switching, object present → output Q LOW</td> </tr> <tr> <td>Function of pin 4/black (BK) – detail</td> <td>The pin 4 function of the sensor can be switched Additional possible settings via operating mode switch</td> </tr> </table>	Function of pin 4/black (BK)	Digital output, light switching, object present → output Q LOW	Function of pin 4/black (BK) – detail	The pin 4 function of the sensor can be switched Additional possible settings via operating mode switch												
Function of pin 4/black (BK)	Digital output, light switching, object present → output Q LOW																
Function of pin 4/black (BK) – detail	The pin 4 function of the sensor can be switched Additional possible settings via operating mode switch																

<sup>1)</sup> Limit values.

<sup>2)</sup> At U<sub>B</sub> > 24 V, I max. = 50 mA.

<sup>3)</sup> With light/dark ratio 1:1.

## MECHANICS

Housing	Rectangular						
Dimensions (W x H x D)	12 mm x 31.5 mm x 21 mm						
Connection	Connector M8, 3-pin						
Material	<table border="0"> <tr> <td>Housing</td> <td>Plastic, ABS</td> </tr> <tr> <td>Front screen</td> <td>Plastic, PMMA</td> </tr> <tr> <td>Male connector</td> <td>Metal, copper alloy (C3604 CUZN39PB3)</td> </tr> </table>	Housing	Plastic, ABS	Front screen	Plastic, PMMA	Male connector	Metal, copper alloy (C3604 CUZN39PB3)
Housing	Plastic, ABS						
Front screen	Plastic, PMMA						
Male connector	Metal, copper alloy (C3604 CUZN39PB3)						
Weight	Approx. 60 g						

**AMBIENT DATA**

Enclosure rating	IP67 (EN 60529)
Ambient operating temperature	-20 °C ... +50 °C <sup>1, 2)</sup>
Ambient temperature, storage	-40 °C ... +70 °C
Typ. Ambient light immunity	Sunlight: ≤ 13,000 lx
Shock resistance	30 g, 11 ms (3 positive and 3 negative shocks along X, Y, Z axes, 18 total shocks (EN60068-2-27))
Vibration resistance	10 Hz ... 55 Hz (Amplitude 0.5 mm, 3 x 30 min (EN60068-2-6))
Air humidity	35 % ... 95 %, relative humidity (no condensation)
Electromagnetic compatibility (EMC)	EN 60947-5-2
UL File No.	NRKH.E348498 & NRKH7.E348498

<sup>1)</sup> As of T<sub>a</sub> => 45 °C, a max. supply voltage U<sub>B</sub> = 24 V and a max. load current I<sub>max</sub> = 50 mA is permitted.

<sup>2)</sup> Below T<sub>v</sub> = -20 °C, a warm-up time of 3 seconds is required.

**CERTIFICATES**

EU declaration of conformity	✓
UK declaration of conformity	✓
ACMA declaration of conformity	✓
Moroccan declaration of conformity	✓
China RoHS	✓
China Compulsory Product Certification (CCC) exempt	✓
cULus certificate	✓
Laser safety (IEC 60825-1) declaration of manufacturer	✓

**DIMENSIONAL DRAWING**

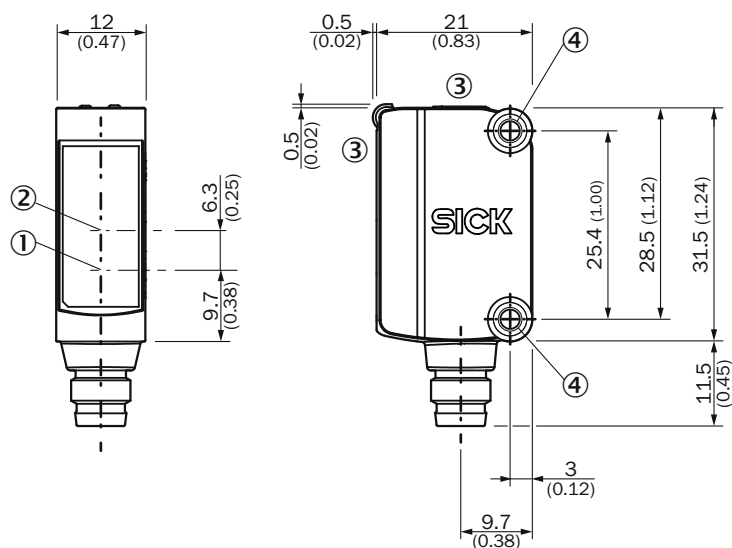

Dimensions in mm (inch)

- ① Center of optical axis, sender
- ② Center of optical axis, receiver
- ③ display and adjustment elements
- ④ Mounting holes M3

**DISPLAY AND ADJUSTMENT ELEMENTS**

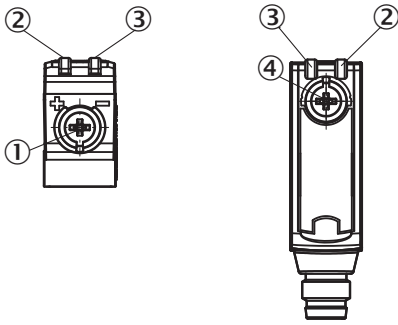

- ① Potentiometer
- ② LED yellow
- ③ LED green
- ④ operating mode switch

**CONNECTION TYPE CONNECTOR M8, 3-PIN**

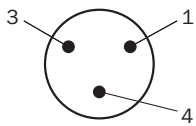

**CONNECTION DIAGRAM CD-045**

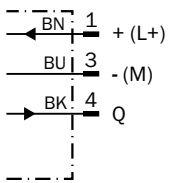

**TRUTH TABLE PNP - LIGHT SWITCHING**

	Light switching Q (normally closed)	
	Object not present → Output HIGH	Object present → Output LOW
Light receive	✔	✘
Light receive indicator	☀	✘
Load resistance	⚡	✘

TRUTH TABLE PNP - DARK SWITCHING

	Dark switching $\bar{Q}$ (normally open)	
	Object not present → Output LOW	Object present → Output HIGH
Light receive	✓	✗
Light receive indicator	☀	✗
Load resistance	✗	⚡

CHARACTERISTIC CURVE

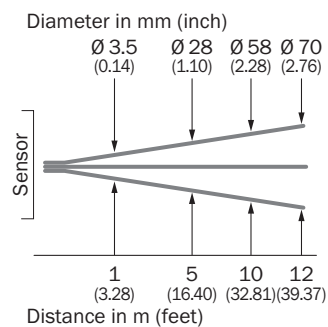

**CHARACTERISTIC CURVE**

Operating reserve

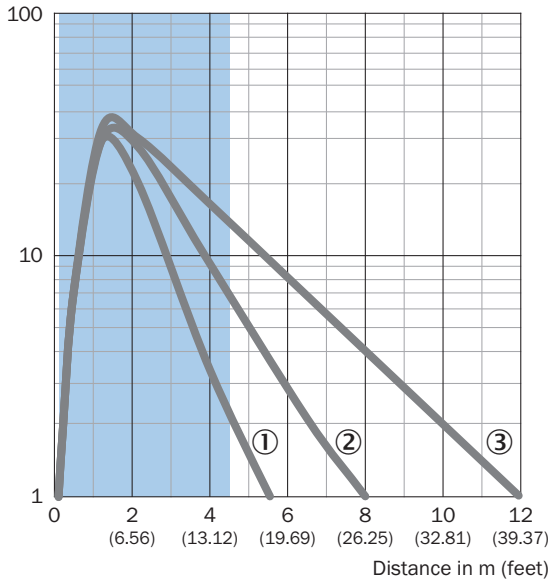

Recommended sensing range for the best performance

- ① PL10F reflector
- ② Reflector PL20F
- ③ Reflector P250F

**SENSING RANGE DIAGRAM**

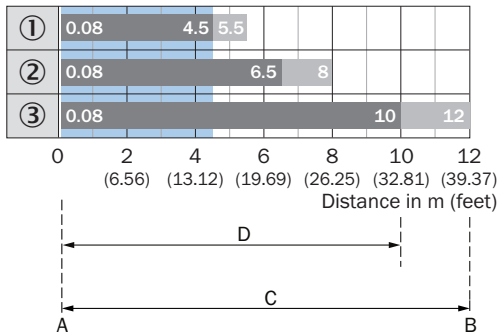

- A = Sensing range min. in m
- B = Sensing range max. in m
- C = Maximum distance range from reflector to sensor (operating reserve 1)
- D = Recommended distance range from reflector to sensor (operating reserve 2)

Recommended sensing range for the best performance

- ① PL10F reflector
- ② Reflector PL20F
- ③ Reflector P250F

Further information as well as suitable accessories, example applications and downloads such as CAD dimensional models, operating instructions and software can be found at [www.sick.com/1117677](http://www.sick.com/1117677)



SICK AG  
WALDKIRCH  
GERMANY  
SICK.COM

# SICK AT A GLANCE

SICK is a leading global technology company for intelligent sensors and integrated solutions in industrial automation. Our technologies set benchmarks, making your industrial processes more efficient, safer and more sustainable – both in logistics and manufacturing operations.

SICK combines sensor intelligence with industry expertise and certified consulting services. We provide the ideal foundation for scalable as well as tailor-made automation solutions and create added value along the entire value chain. Our close partnerships with our customers are more than just a promise: Together, we optimize productivity, improve quality, protect health and safety, and help build a sustainable future. All with empathy and trust.

Since 1946, we have been developing innovative technologies with passion and a pioneering spirit. With a global network in around 40 countries, SICK has a global presence and is always close by. The company's headquarters are located in Waldkirch near Freiburg, Germany. Our customers benefit from our understanding of both local and global requirements, which enables us to deliver tailor-made solutions

**SICK**  
Sensor Intelligence