

SICK.COM



DATA SHEET

GTB6L-P3211

G6
Photoelectric sensors

SICK Sensor Intelligence

PHOTOELECTRIC SENSORS

GTB6L-P3211

ORDERING INFORMATION

Type	part no.
GTB6L-P3211	1117820

Further device versions and accessories at www.sick.com/G6



Illustration may differ



DETAILED TECHNICAL DATA

FEATURES

Functional principle	Photoelectric proximity sensor	
Functional principle detail	Background suppression	
Sensing range	Sensing range min.	10 mm
	Sensing range max.	400 mm
Adjustable switching threshold for background suppression	30 mm ... 400 mm	
Reference object	Object with 90% remission factor (complies with standard white according to DIN 5033)	
Minimum distance between set sensing range and background (black 6% / white 90%)	3 mm, at a distance of 75 mm	
Recommended sensing range for the best performance	30 mm ... 180 mm	
Emitted beam	Light source	Laser
	Type of light	Visible red light
	Shape of light spot	Point-shaped
	Light spot size (distance)	Ø 0.4 mm (150 mm)
Maximum dispersion of the emitted beam around the standardized transmission axis (squint angle)	< +/- 1.5° (at T ₀ = +23 °C)	
Key laser figures	Normative reference	IEC 60825-1 / CDRH 21 CFR 1040.10 & 1040.11
	Laser class	1 ¹⁾
	Wave length	680 nm
	Pulse duration	2 µs
	Maximum pulse power	≤ 11.9 mW
	Average service life	100,000 h at T _a = +25 °C
Smallest detectable object (MDO) typ.	0.4 mm, at 150 mm distance (object with 90% remission factor (corresponds to standard white according to DIN 5033))	
Adjustment	Potentiometer	For setting the sensing range, 5 rotations

¹⁾ Do not intentionally look into the laser beam. Never point the laser beam at people's eyes.

	Operating mode switch	For inverting the switching function (light/dark switching)
Display	LED green	Operating indicator Static on: power on
	LED yellow	Status of received light beam Static on: object present Static off: object not present

¹⁾ Do not intentionally look into the laser beam. Never point the laser beam at people's eyes.

SAFETY-RELATED PARAMETERS

MTTF _D	662 years
DC _{avg}	0 %
T _M (mission time)	10 years

ELECTRONICS

Supply voltage U _B	10 V DC ... 30 V DC ¹⁾																
Ripple	< 5 V _{pp}																
Usage category	DC-13 (According to EN 60947-5-2)																
Current consumption	≤ 20 mA, without load. At U _B = 24 V																
Protection class	III																
Digital output	<table border="0"> <tr> <td>Number</td> <td>1</td> </tr> <tr> <td>Type</td> <td>PNP</td> </tr> <tr> <td>Switching mode</td> <td>Light/dark switching</td> </tr> <tr> <td>Signal voltage PNP HIGH/LOW</td> <td>Approx. U_B - 3 V / 0 V</td> </tr> <tr> <td>Output current I_{max.}</td> <td>≤ 100 mA ²⁾</td> </tr> <tr> <td>Circuit protection outputs</td> <td>Reverse polarity protected Overcurrent protected Short-circuit protected</td> </tr> <tr> <td>Response time</td> <td>≤ 625 μs</td> </tr> <tr> <td>Switching frequency</td> <td>1,000 Hz ³⁾</td> </tr> </table>	Number	1	Type	PNP	Switching mode	Light/dark switching	Signal voltage PNP HIGH/LOW	Approx. U _B - 3 V / 0 V	Output current I _{max.}	≤ 100 mA ²⁾	Circuit protection outputs	Reverse polarity protected Overcurrent protected Short-circuit protected	Response time	≤ 625 μs	Switching frequency	1,000 Hz ³⁾
Number	1																
Type	PNP																
Switching mode	Light/dark switching																
Signal voltage PNP HIGH/LOW	Approx. U _B - 3 V / 0 V																
Output current I _{max.}	≤ 100 mA ²⁾																
Circuit protection outputs	Reverse polarity protected Overcurrent protected Short-circuit protected																
Response time	≤ 625 μs																
Switching frequency	1,000 Hz ³⁾																
Pin/Wire assignment	<table border="0"> <tr> <td>Function of pin 4/black (BK)</td> <td>Digital output, light switching, object present → output Q HIGH</td> </tr> <tr> <td>Function of pin 4/black (BK) – detail</td> <td>The pin 4 function of the sensor can be switched Additional possible settings via operating mode switch</td> </tr> </table>	Function of pin 4/black (BK)	Digital output, light switching, object present → output Q HIGH	Function of pin 4/black (BK) – detail	The pin 4 function of the sensor can be switched Additional possible settings via operating mode switch												
Function of pin 4/black (BK)	Digital output, light switching, object present → output Q HIGH																
Function of pin 4/black (BK) – detail	The pin 4 function of the sensor can be switched Additional possible settings via operating mode switch																

¹⁾ Limit values.

²⁾ At U_B > 24 V, I max. = 50 mA.

³⁾ With light/dark ratio 1:1.

MECHANICS

Housing	Rectangular								
Dimensions (W x H x D)	12 mm x 31.5 mm x 21 mm								
Connection	Connector M8, 3-pin								
Material	<table border="0"> <tr> <td>Housing</td> <td>Plastic, ABS</td> </tr> <tr> <td>Front screen</td> <td>Plastic, PMMA</td> </tr> <tr> <td>Cable</td> <td>Plastic, PVC</td> </tr> <tr> <td>Male connector</td> <td>Metal, copper alloy (C3604 CUZN39PB3)</td> </tr> </table>	Housing	Plastic, ABS	Front screen	Plastic, PMMA	Cable	Plastic, PVC	Male connector	Metal, copper alloy (C3604 CUZN39PB3)
Housing	Plastic, ABS								
Front screen	Plastic, PMMA								
Cable	Plastic, PVC								
Male connector	Metal, copper alloy (C3604 CUZN39PB3)								
Weight	Approx. 60 g								

AMBIENT DATA

Enclosure rating	IP67 (EN 60529)
Ambient operating temperature	-20 °C ... +50 °C ^{1, 2)}
Ambient temperature, storage	-40 °C ... +70 °C
Typ. Ambient light immunity	Sunlight: ≤ 13,000 lx
Shock resistance	30 g, 11 ms (3 positive and 3 negative shocks along X, Y, Z axes, 18 total shocks (EN60068-2-27))
Vibration resistance	10 Hz ... 55 Hz (Amplitude 0.5 mm, 3 x 30 min (EN60068-2-6))
Air humidity	35 % ... 95 %, relative humidity (no condensation)
Electromagnetic compatibility (EMC)	EN 60947-5-2
UL File No.	NRKH.E348498 & NRKH7.E348498

¹⁾ As of T_a => 45 °C, a max. supply voltage U_B = 24 V and a max. load current I_{max} = 50 mA is permitted.

²⁾ Below T_v = -20 °C, a warm-up time of 3 seconds is required.

CERTIFICATES

EU declaration of conformity	✓
UK declaration of conformity	✓
ACMA declaration of conformity	✓
Moroccan declaration of conformity	✓
China RoHS	✓
China Compulsory Product Certification (CCC) exempt	✓
cULus certificate	✓
Laser safety (IEC 60825-1) declaration of manufacturer	✓

DIMENSIONAL DRAWING

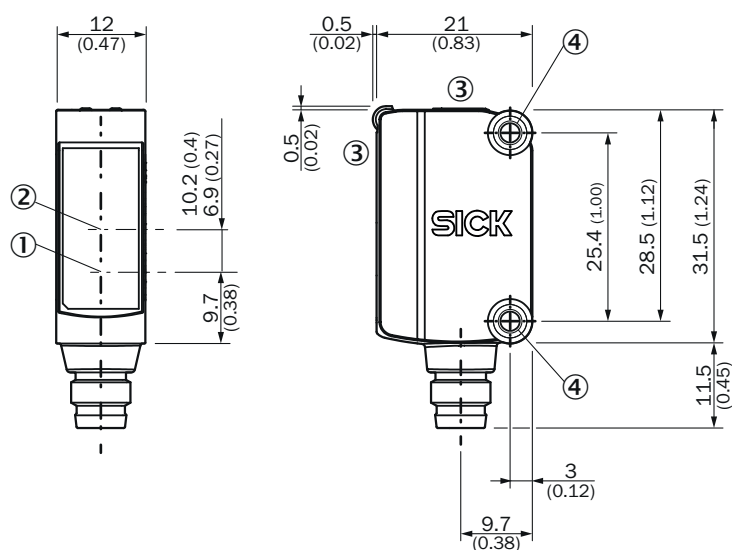

Dimensions in mm (inch)

- ① Center of optical axis, sender
- ② Center of optical axis, receiver
- ③ display and adjustment elements
- ④ Mounting holes M3

DISPLAY AND ADJUSTMENT ELEMENTS

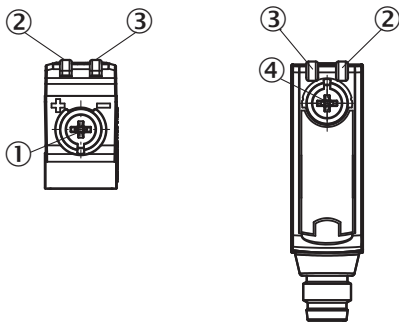

- ① Potentiometer
- ② LED yellow
- ③ LED green
- ④ operating mode switch

CONNECTION TYPE CONNECTOR M8, 3-PIN

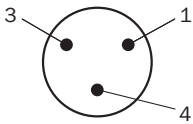

CONNECTION DIAGRAM CD-045

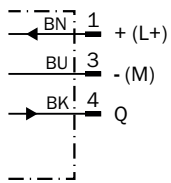

TRUTH TABLE PNP - LIGHT SWITCHING

	Light switching Q (normally open)	
	Object not present → Output LOW	Object present → Output HIGH
Light receive	✗	✔
Light receive indicator	✗	☀
Load resistance	✗	⚡

TRUTH TABLE PNP - DARK SWITCHING

	Dark switching \bar{Q} (normally closed)	
	Object not present → Output HIGH	Object present → Output LOW
Light receive	⊗	✔
Light receive indicator	⊗	☀
Load resistance	⚡	⊗

CHARACTERISTIC CURVE

Minimum distance in mm (y) between the set sensing range (x) and white background (90% remission)

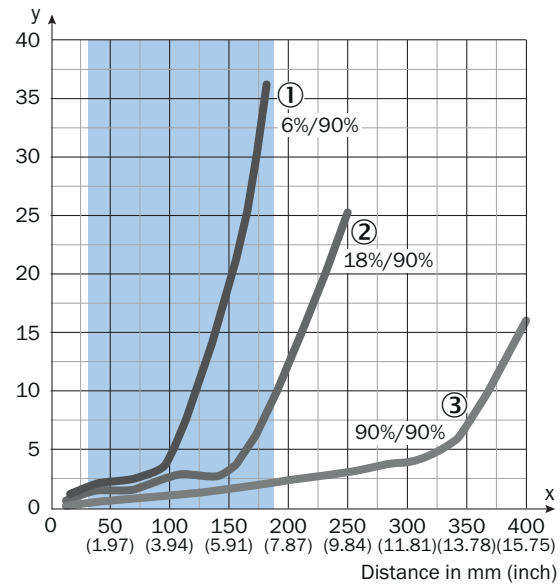

- Recommended sensing range for the best performance
- ① Black object, 6% remission factor
- ② Gray object, 18% remission factor
- ③ White object, 90% remission factor

Example:
Safe suppression of the background

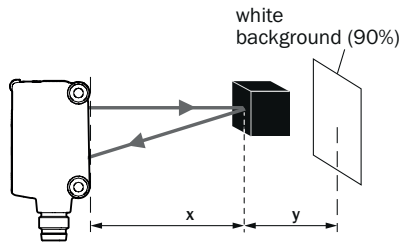

Black object (6% remission)
Set sensing range x = 150 mm. Needed minimum distance to white background y = 20 mm.

LIGHT SPOT SIZE

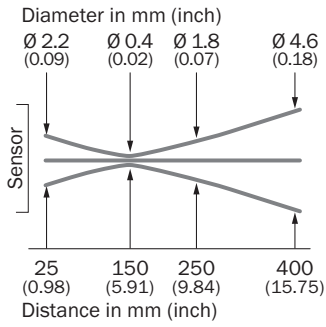

SENSING RANGE DIAGRAM

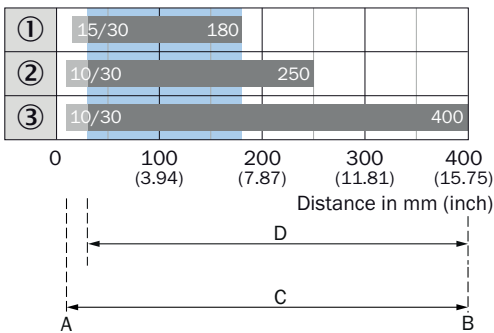

- A = Sensing range min. in mm
- B = Sensing range max. in mm
- C = Viewing range
- D = Adjustable switching threshold for background suppression

Recommended sensing range for the best performance

- ① Black object, 6% remission factor
- ② Gray object, 18% remission factor
- ③ White object, 90% remission factor

Further information as well as suitable accessories, example applications and downloads such as CAD dimensional models, operating instructions and software can be found at www.sick.com/1117820



SICK AG
WALDKIRCH
GERMANY
SICK.COM

SICK AT A GLANCE

SICK is a leading global technology company for intelligent sensors and integrated solutions in industrial automation. Our technologies set benchmarks, making your industrial processes more efficient, safer and more sustainable – both in logistics and manufacturing operations.

SICK combines sensor intelligence with industry expertise and certified consulting services. We provide the ideal foundation for scalable as well as tailor-made automation solutions and create added value along the entire value chain. Our close partnerships with our customers are more than just a promise: Together, we optimize productivity, improve quality, protect health and safety, and help build a sustainable future. All with empathy and trust.

Since 1946, we have been developing innovative technologies with passion and a pioneering spirit. With a global network in around 40 countries, SICK has a global presence and is always close by. The company's headquarters are located in Waldkirch near Freiburg, Germany. Our customers benefit from our understanding of both local and global requirements, which enables us to deliver tailor-made solutions

SICK
Sensor Intelligence