

SICK.COM



DATA SHEET

GTB6SP-21A1116EZZZ

G6
Photoelectric sensors

SICK Sensor Intelligence

PHOTOELECTRIC SENSORS

GTB6SP-21A1116EZZZ

ORDERING INFORMATION

Type	part no.
GTB6SP-21A1116EZZZ	1151881

Further device versions and accessories at www.sick.com/G6



Illustration may differ



DETAILED TECHNICAL DATA

FEATURES

Functional principle	Photoelectric proximity sensor	
Functional principle detail	Background suppression	
Sensing range	Sensing range min.	5 mm
	Sensing range max.	400 mm
Adjustable switching threshold for background suppression	35 mm ... 400 mm	
Minimum distance between set sensing range and background (black 6% / white 90%)	5 mm, at a distance of 120 mm	
Recommended sensing range for the best performance	35 mm ... 140 mm	
Emitted beam	Light source	PinPoint LED
	Type of light	Visible red light
	Shape of light spot	Point-shaped
	Light spot size (distance)	Ø 5.6 mm (150 mm)
Key LED figures	Normative reference	EN 62471:2008-09 IEC 62471:2006, modified
	LED risk group marking	Free group
	Wave length	640 nm
	Average service life	100,000 h at T _a = +25 °C
Smallest detectable object (MDO) typ.	Object with 90% remission factor (complies with standard white according to DIN 5033)	
Adjustment	Potentiometer	For setting the sensing range, 5 rotations
	Operating mode switch	For inverting the switching function (light/dark switching)
Display	LED green	Operating indicator Static on: power on
	LED yellow	Status of received light beam Static on: object present Static off: object not present

ELECTRONICS

Supply voltage U_B	10 V DC ... 30 V DC ¹⁾																
Ripple	$\leq 5 V_{pp}$																
Usage category	DC-12 (According to EN 60947-5-2) DC-13 (According to EN 60947-5-2)																
Current consumption	≤ 20 mA, without load. At $U_B = 24$ V																
Protection class	III																
Digital output	<table border="0"> <tr> <td>Number</td> <td>1</td> </tr> <tr> <td>Type</td> <td>PNP</td> </tr> <tr> <td>Switching mode</td> <td>Light/dark switching</td> </tr> <tr> <td>Signal voltage PNP HIGH/LOW</td> <td>Approx. $U_B - 3$ V / 0 V</td> </tr> <tr> <td>Output current I_{max}</td> <td>≤ 100 mA ²⁾</td> </tr> <tr> <td>Circuit protection outputs</td> <td>Reverse polarity protected Overcurrent protected Short-circuit protected</td> </tr> <tr> <td>Response time</td> <td>≤ 625 μs ³⁾</td> </tr> <tr> <td>Switching frequency</td> <td>1,000 Hz ⁴⁾</td> </tr> </table>	Number	1	Type	PNP	Switching mode	Light/dark switching	Signal voltage PNP HIGH/LOW	Approx. $U_B - 3$ V / 0 V	Output current I_{max}	≤ 100 mA ²⁾	Circuit protection outputs	Reverse polarity protected Overcurrent protected Short-circuit protected	Response time	≤ 625 μ s ³⁾	Switching frequency	1,000 Hz ⁴⁾
Number	1																
Type	PNP																
Switching mode	Light/dark switching																
Signal voltage PNP HIGH/LOW	Approx. $U_B - 3$ V / 0 V																
Output current I_{max}	≤ 100 mA ²⁾																
Circuit protection outputs	Reverse polarity protected Overcurrent protected Short-circuit protected																
Response time	≤ 625 μ s ³⁾																
Switching frequency	1,000 Hz ⁴⁾																
Pin/Wire assignment	<table border="0"> <tr> <td>Function of pin 4/black (BK)</td> <td>Digital output, light switching, object present \rightarrow output Q HIGH</td> </tr> <tr> <td>Function of pin 4/black (BK) – detail</td> <td>The pin 4 function of the sensor can be switched Additional possible settings via operating mode switch</td> </tr> </table>	Function of pin 4/black (BK)	Digital output, light switching, object present \rightarrow output Q HIGH	Function of pin 4/black (BK) – detail	The pin 4 function of the sensor can be switched Additional possible settings via operating mode switch												
Function of pin 4/black (BK)	Digital output, light switching, object present \rightarrow output Q HIGH																
Function of pin 4/black (BK) – detail	The pin 4 function of the sensor can be switched Additional possible settings via operating mode switch																

¹⁾ Limit values.²⁾ At $U_B > 24$ V, $I_{max} = 50$ mA.³⁾ Signal transit time with resistive load.⁴⁾ With light/dark ratio 1:1.**MECHANICS**

Housing	Rectangular						
Dimensions (W x H x D)	12 mm x 31.6 mm x 21 mm						
Connection	Connector M8, 3-pin						
Material	<table border="0"> <tr> <td>Housing</td> <td>Plastic, ABS</td> </tr> <tr> <td>Front screen</td> <td>Plastic, PMMA</td> </tr> <tr> <td>Male connector</td> <td>Metal, copper alloy (C3604 CUZN39PB3)</td> </tr> </table>	Housing	Plastic, ABS	Front screen	Plastic, PMMA	Male connector	Metal, copper alloy (C3604 CUZN39PB3)
Housing	Plastic, ABS						
Front screen	Plastic, PMMA						
Male connector	Metal, copper alloy (C3604 CUZN39PB3)						
Weight	Approx. 10 g						
Maximum tightening torque of the fixing screws	0.4 Nm						

AMBIENT DATA

Enclosure rating	IP67 (EN 60529)
Ambient operating temperature	-30 °C ... $+55$ °C
Ambient temperature, storage	-40 °C ... $+70$ °C
Typ. Ambient light immunity	Sunlight: $\leq 30,000$ lx
Shock resistance	11 ms (3 positive and 3 negative shocks along X, Y, Z axes, 18 total shocks (EN60068-2-27))
Vibration resistance	10 Hz ... 55 Hz (Amplitude 0.5 mm, 3 x 30 min (EN60068-2-6))
Air humidity	35 % ... 95 %, relative humidity (no condensation)
Electromagnetic compatibility (EMC)	EN 60947-5-2
UL File No.	NRKH.E348498 & NRKH7.E348498

CERTIFICATES

EU declaration of conformity	✓
------------------------------	---

CONNECTION TYPE CONNECTOR M8, 3-PIN

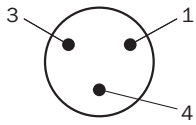

CONNECTION DIAGRAM CD-045

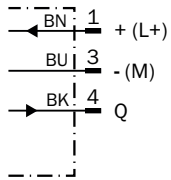

TRUTH TABLE PNP - LIGHT SWITCHING Q

	Light switching Q (normally open)	
	Object not present → Output LOW	Object present → Output HIGH
Light receive	✗	✔
Light receive indicator	✗	☀
Load resistance	✗	⚡

CHARACTERISTIC CURVE

Minimum distance in mm (y) between the set sensing range and white background (90 % remission factor)

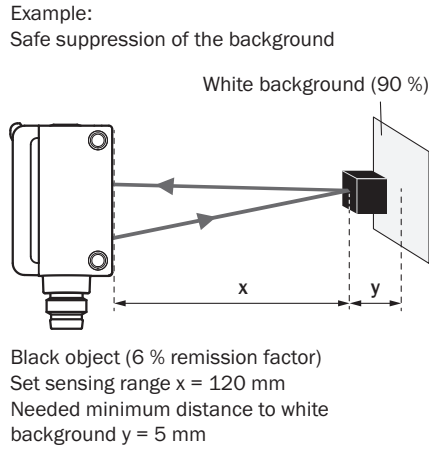
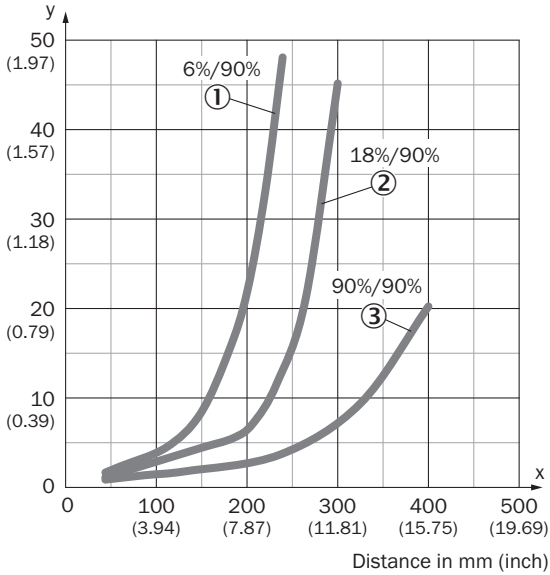

- ① Black object, 6% remission factor
- ② Gray object, 18% remission factor
- ③ White object, 90% remission factor

LIGHT SPOT SIZE

Dimensions in mm (inch)

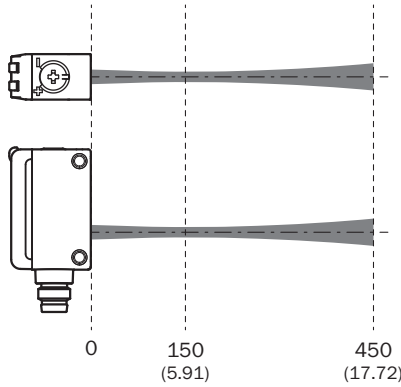
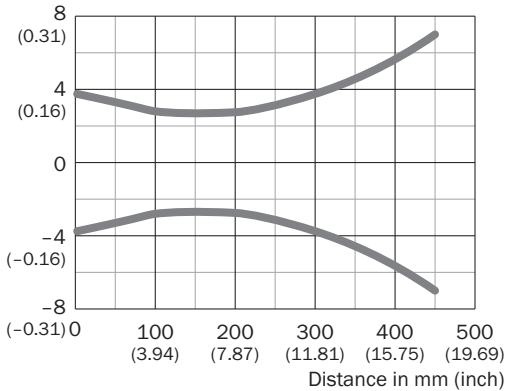

SENSING RANGE DIAGRAM

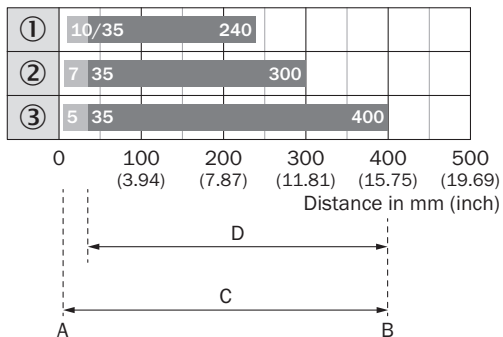

1	Black object, 6% remission factor
2	Gray object, 18% remission factor
3	White object, 90% remission factor
A	Sensing range min. in mm
B	Sensing range max. in mm
C	Maximum distance range from sensor to object
D	Recommended distance range from sensor to object

Further information as well as suitable accessories, example applications and downloads such as CAD dimensional models, operating instructions and software can be found at www.sick.com/1151881



SICK AG
WALDKIRCH
GERMANY
SICK.COM

SICK AT A GLANCE

SICK is a leading global technology company for intelligent sensors and integrated solutions in industrial automation. Our technologies set benchmarks, making your industrial processes more efficient, safer and more sustainable – both in logistics and manufacturing operations.

SICK combines sensor intelligence with industry expertise and certified consulting services. We provide the ideal foundation for scalable as well as tailor-made automation solutions and create added value along the entire value chain. Our close partnerships with our customers are more than just a promise: Together, we optimize productivity, improve quality, protect health and safety, and help build a sustainable future. All with empathy and trust.

Since 1946, we have been developing innovative technologies with passion and a pioneering spirit. With a global network in around 40 countries, SICK has a global presence and is always close by. The company's headquarters are located in Waldkirch near Freiburg, Germany. Our customers benefit from our understanding of both local and global requirements, which enables us to deliver tailor-made solutions

SICK
Sensor Intelligence