

SICK.COM



DATA SHEET

# IME30-20NPSZW2S

IME  
Inductive proximity sensors

**SICK** Sensor Intelligence

## INDUCTIVE PROXIMITY SENSORS

## IME30-20NPSZW2S

## ORDERING INFORMATION

Type	part no.
IME30-20NPSZW2S	1041048

Further device versions and accessories at [www.sick.com/IME](http://www.sick.com/IME)



Illustration may differ



## DETAILED TECHNICAL DATA

## FEATURES

Housing	Metric
Housing	Standard design
Thread size	M30 x 1.5
Diameter	Ø 30 mm
Sensing range $S_n$	20 mm
Safe sensing range $S_s$	16.2 mm
Installation type	Non-flush
Switching frequency	500 Hz
Connection type	Cable, 3-wire, 2 m
Switching output	PNP
Switching output detail	PNP
Output function	NO
Electrical wiring	DC 3-wire
Enclosure rating	IP67 <sup>1)</sup>
Items supplied	Mounting nut, brass, nickel-plated (2x)

<sup>1)</sup> According to EN 60529.

**MECHANICS/ELECTRONICS**

Supply voltage	10 V DC ... 30 V DC
Ripple	≤ 10 %
Voltage drop	≤ 2 V <sup>1)</sup>
Time delay before availability	≤ 125 ms
Hysteresis	5 % ... 15 %
Reproducibility	≤ 2 % <sup>2)</sup> <sup>3)</sup>
Temperature drift (of S <sub>i</sub> )	± 10 %
EMC	According to EN 60947-5-2
Continuous current I <sub>a</sub>	≤ 200 mA
No load current	≤ 10 mA
Cable material	PVC
Conductor size	0.25 mm <sup>2</sup>
Cable diameter	Ø 3.9 mm
Short-circuit protection	✓
Power-up pulse protection	✓
Shock and vibration resistance	30 g, 11 ms/10 Hz ... 55 Hz, 1 mm
Ambient operating temperature	-25 °C ... +75 °C
Housing material	Brass, nickel-plated
Sensing face material	Plastic, PA 66
Housing length	70 mm
Thread length	41 mm
Tightening torque, max.	≤ 100 Nm
UL File No.	NRKH.E181493

<sup>1)</sup> At I<sub>a</sub> max.<sup>2)</sup> Supply voltage U<sub>0</sub> and constant ambient temperature T<sub>a</sub>.<sup>3)</sup> Of S<sub>r</sub>.**SAFETY-RELATED PARAMETERS**

MTTF <sub>0</sub>	1,735 years
DC <sub>avg</sub>	0 %

**REDUCTION FACTORS**

Note	The values are reference values which may vary
St37 steel (Fe)	1
Stainless steel (V2A, 304)	Approx. 0.8
Aluminum (Al)	Approx. 0.45
Copper (Cu)	Approx. 0.4
Brass (Br)	Approx. 0.4

**INSTALLATION NOTE**

Remark	Associated graphic see "Installation"
A	30 mm
B	60 mm
C	30 mm
D	60 mm

E	40 mm
F	160 mm

**CERTIFICATES**

EU declaration of conformity	✓
UK declaration of conformity	✓
ACMA declaration of conformity	✓
Moroccan declaration of conformity	✓
China RoHS	✓
China Compulsory Product Certification (CCC) exempt	✓
cULus certificate	✓

**INSTALLATION NOTE NON-FLUSH INSTALLATION**

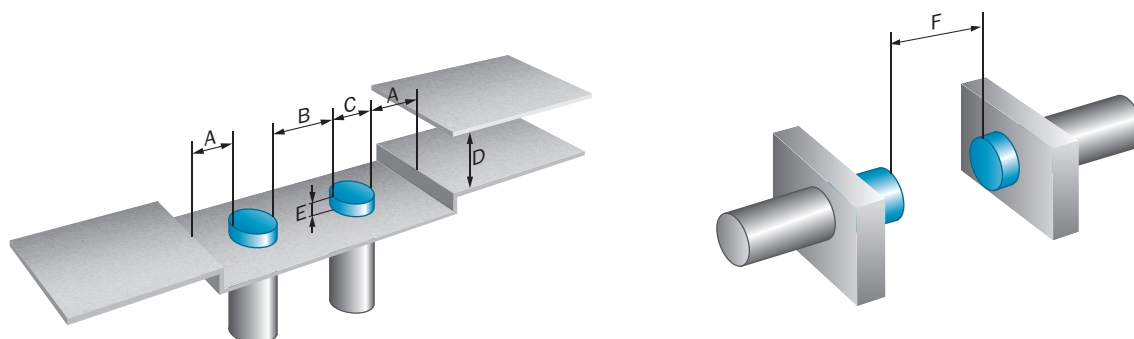

**CONNECTION DIAGRAM CD-001**

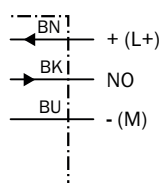

**DIMENSIONAL DRAWING IME30 STANDARD, CABLE, NON-FLUSH**

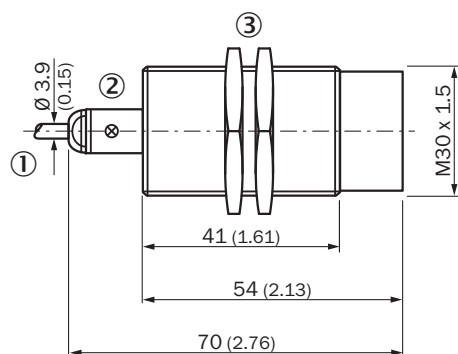

Dimensions in mm (inch)

- ① Connection
- ② Display LED
- ③ Fastening nuts (2x); width across 36, metal

Further information as well as suitable accessories, example applications and downloads such as CAD dimensional models, operating instructions and software can be found at [www.sick.com/1041048](http://www.sick.com/1041048)



SICK AG  
WALDKIRCH  
GERMANY  
SICK.COM

# SICK AT A GLANCE

SICK is a leading global technology company for intelligent sensors and integrated solutions in industrial automation. Our technologies set benchmarks, making your industrial processes more efficient, safer and more sustainable – both in logistics and manufacturing operations.

SICK combines sensor intelligence with industry expertise and certified consulting services. We provide the ideal foundation for scalable as well as tailor-made automation solutions and create added value along the entire value chain. Our close partnerships with our customers are more than just a promise: Together, we optimize productivity, improve quality, protect health and safety, and help build a sustainable future. All with empathy and trust.

Since 1946, we have been developing innovative technologies with passion and a pioneering spirit. With a global network in around 40 countries, SICK has a global presence and is always close by. The company's headquarters are located in Waldkirch near Freiburg, Germany. Our customers benefit from our understanding of both local and global requirements, which enables us to deliver tailor-made solutions

**SICK**  
Sensor Intelligence